

# Towel Rail Radiator 35mm Tube

## Important Notes:

- Ensure there is no trapped air in the radiator by adequately bleeding the system during installation.
- Flow rate may need to be adjusted/balanced for optimum performance.

General information: The installation and commissioning of the system should comply with BS EN 14336:2004. On completion of the installation, the system should be properly flushed and filled in accordance with the British Code of Practice for the Treatment of Water in Domestic Hot Water Central Heating Systems (BS 7593:2006). We strongly recommend the use of a corrosion inhibitor. Failure to comply with these standards may invalidate the manufacturer's warranty.

All dimensions are in mm.

**Merriott UK & Ireland**  
Purmo Group (UK) Ltd,  
Eastern Avenue,  
Team Valley, Gateshead,  
Tyne & Wear, NE11 0PG  
Tel: 0330 0415 472

sales@merriottuk.com  
sales@merriott.ie

www.merriottuk.com / www.merriott.ie  
Follow us on  @merriottuk and 

## 35MM TOWEL RADIATOR

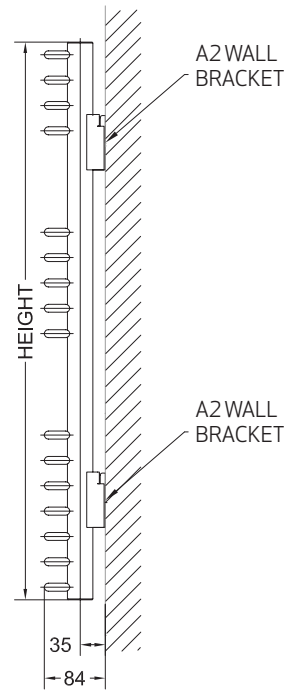

## BRACKET MOUNTING AND PIPE CENTRE DETAILS

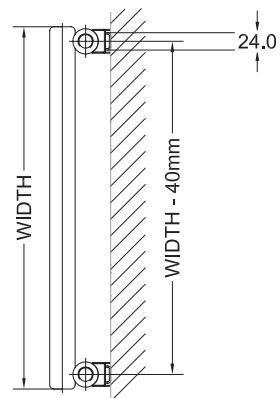

## CONNECTION DETAILS

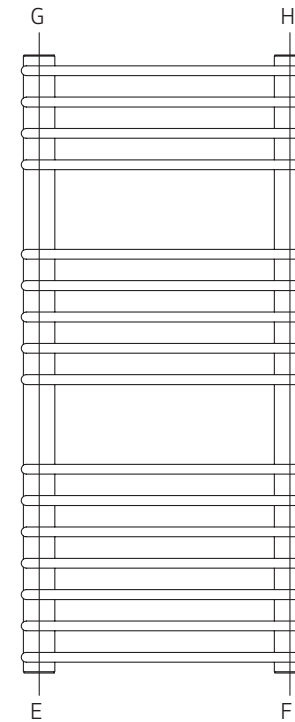

STANDARD CONNECTIONS  
E,F,G,H

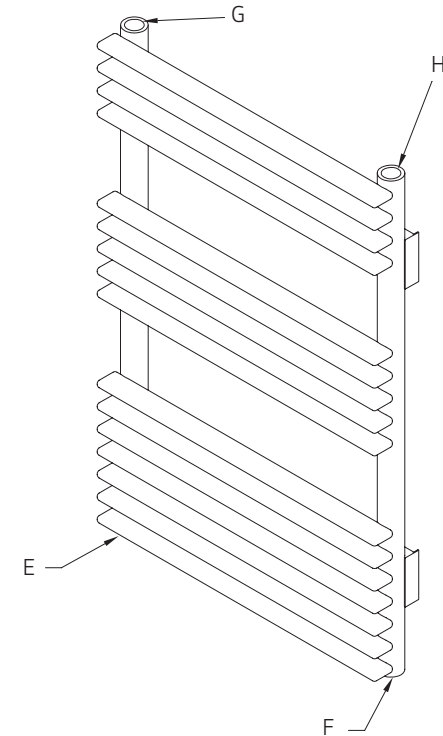

## CONNECTION LADDER

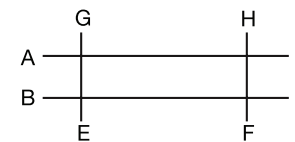

# Towel Rail Radiator 35mm Tube

## Installation Procedure:

1. Choose the location where you wish to install the towel radiator and mark the positions for the wall brackets with a pencil as indicated in FIG.1.
2. Measure the width & height as indicated in FIG.1.
3. Place the wall brackets over the pencil marks on the wall as shown by points 1, 2, 3 & 4 in FIG. 1 and mark the positions of the wall plugs and screws as indicated in FIG. 2.
4. Drill the necessary holes in the wall and install the wall brackets.
5. Fit air vents/blanks to the radiator.
6. Mount the radiator on to the wall brackets.
7. Connect the water supply via the flow.
8. The return line of the central heating system is connected to the opposite side of the radiator via the lock shield valve.
9. Fill the radiator and purge the air from the radiator using the air vent if required.

RADIATOR LOCATION  
ON WALL FOR TOWEL RAILS

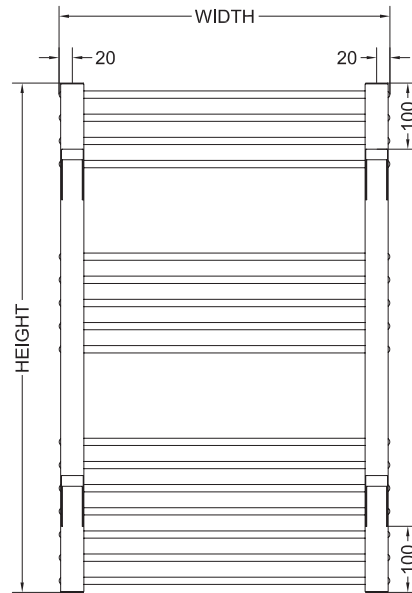

MOUNTING LUG LOCATIONS  
FIG. 1

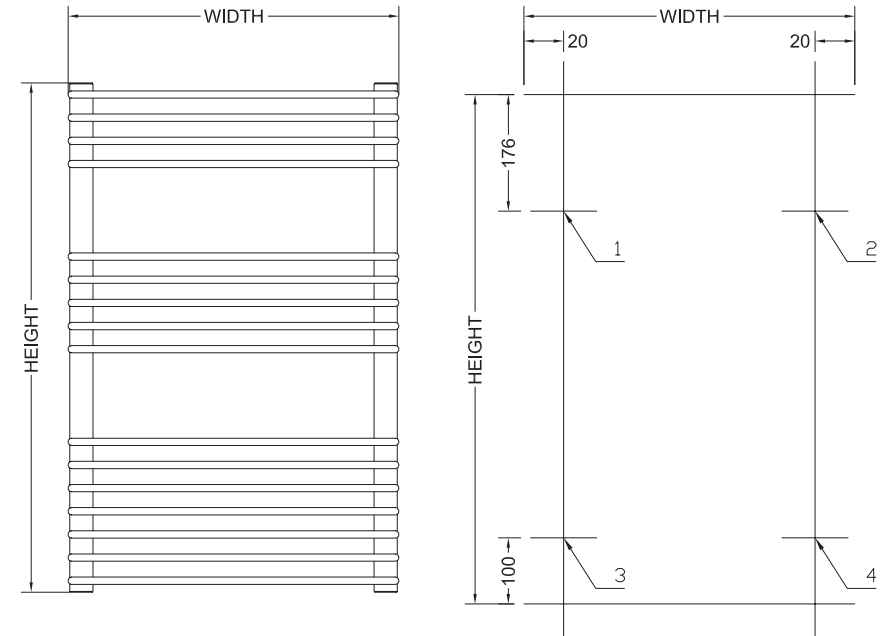

BRACKET LOCATION ON WALL  
FIG. 2

